

# TRIO

Design: team form ag





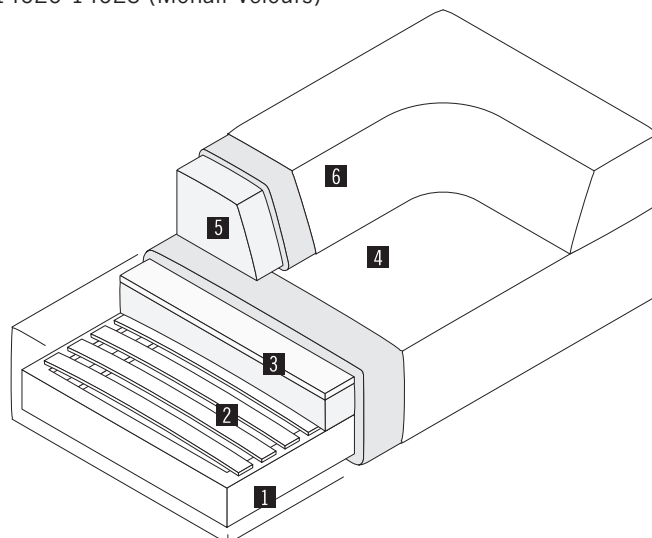

- Verarbeitung:
- 1 Gestellrahmen: Kantholzkonstruktion aus massiver Buche, gedübelt. Seitenteile aus Birkenspertholz.
  - 2 Sitzunterfederung: Lattenrost aus Buchen-Federholzleisten.
  - 3 Langzeitkomfort im Sitz: Qualitätspolyäther mit schonender Vliesabdeckung.
  - 4 Abziehbare Bezüge nach Europa-Patent.
  - 5 Langzeitkomfort im Rücken: Qualitätspolyäther mit schonender Vliesabdeckung.
  - 6 Abziehbare Bezüge. Unterseite mit Bremsmaterial. Die Rücken werden nur auf den Sitz aufgelegt, dadurch ist ein freies Positionieren des Rückens auf der Sitzfläche möglich. Leichtes Verrutschen des Rückens auf der Sitzfläche ist modellbedingt.
- Auf den Sitzflächen können naturgemäß s.g. Sitzspiegel auftreten. Diese Sitzspiegel im Bezug lassen sich nicht immer vermeiden und treten manchmal stärker und manchmal schwächer auf, je nach Modell und nach gewähltem Bezugsmaterial. Sitzspiegel sind kein Qualitätsmangel und lassen sich material- und modellbedingt nicht völlig ausschließen.
  - **Wir empfehlen folgende Stoffe/Stoffbügel:**  
5010-5028, 7001-7018, 7080-7089, 7145-7155+7074-7076, 8070-8081, **8120, 8130, 8140 (NEU)**, 10001-10018 (Hallingdal), 9700-9727, **10050-10052 (NEU)**, 12040-12052, 12060-12093

**Technisch verarbeiten können wir außerdem diese Stoffe:**  
6070-6079, 9560-9578 (Stellcut Trio/Steelcut), 9601-9844 (Divina)

**NICHT auf Trio verarbeiten können wir Leder und die folgenden Stoffe/Stoffbügel:**  
6020-6026+6080-6087, 7020-7023, 8101-8106+8110-8114, 7170-7197, 8001-8008+8010-8015+8016-8018+8020, 8030-8050, 9020-9033 (Canvas), 10040--10049,14020-14025 (Mohair-Velours)











# TRIO

Modell-Nr.							
	Hocker- element 50 cm	Sitz- element 100 cm	Sitz- element 150 cm	Sitz- element 200 cm	Sitz- element 300 cm	Element- verbinder (1 Stk.)	Bettbezug in weiß 100 x 200 cm  60° C waschbar
<b>Maße in cm</b>							
Breite x Tiefe	50 x 100	100 x 100	150 x 100	200 x 100	300 x 100		100 x 200
Höhe	38	38	38	38	38		
Sitztiefe	60	60	60	60	60		
Sitzhöhe	38	38	38	38	38		
Armlehnenhöhe	66	66	66	66	66		
Stoffbedarf m/Lederbed. siehe S.1 * komplett	1,90	3,50	4,00	4,60	6,70		







# TRIO

## Rückenelemente

<b>Modell-Nr.</b>								
	Rücken, gerade 100 cm	Rücken, gerade 150 cm	Rücken, gerade 200 cm	Eckrücken, 100 cm	Eckrücken, links 150 cm	Eckrücken, rechts 150 cm	Eckrücken, links 200 cm	Eckrücken, rechts 200 cm
<b>Maße in cm</b> Breite x Tiefe Höhe	100 x 40 28	150 x 40 28	200 x 40 28	100 x 100 28	150 x 100 28	150 x 100 28	200 x 100 28	200 x 100 28
Stoffbedarf m/Lederbed. siehe S.1 * komplett	1,80	2,30	2,90	2,40	2,80	2,80	3,40	3,40









# TRIO

## Kissen

							
<b>Modell-Nr.</b>	Rücken- kissen 75 cm	Rücken- kissen mit Rolle 75 cm	Rücken- kissen 90 cm	Rücken- kissen mit Rolle 90 cm	Daunen- Kuschel- kissen	Daunen- Kuschel- kissen	Kuschel- kissen Füllung: Luftzellen- stäbchen
<b>Maße in cm</b> Breite Höhe Tiefe	75 50 12	75 50 12	90 50 12	90 50 12	50 50	55 55	45 45
Stoffbedarf m/Lederbed. siehe S.1 * komplett	1,00	1,60	1,20	1,80	0,65	0,70	0,55

# TRIO

Vorzugskombinationen

Modell-Nr.	 <b>159010</b>	 <b>159001</b>	 <b>159020</b>	 <b>159002</b>	 <b>159030</b>	 <b>159003</b>	 <b>159040</b>	 <b>159050</b>
	Element- konfi- guration	Element- konfi- guration	Element- konfi- guration	Element- konfi- guration	Element- konfi- guration	Element- konfi- guration	Element- konfi- guration	Element- konfi- guration
<b>Maße siehe Folgeseite!</b>  Stoffbedarf m/Lederbed. siehe S.1 * komplett	13,80	13,80	16,70	16,70	20,70	20,70	20,60	15,80

# TRIO

## Vorzugskombinationen

